





▪

▪

▪

▪

▪

▪

▪

▪

▪

▪

▪

▪

▪

-
-
-

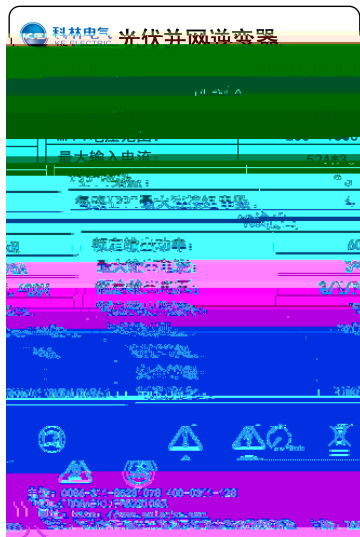
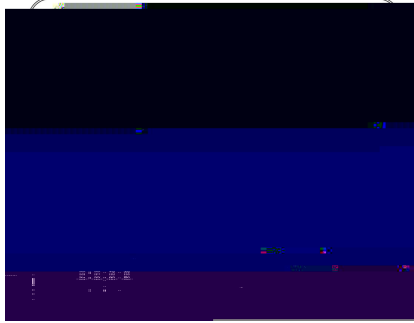

| | |
|--|--|
| | |
| | |
| | |
| | |



| | | | |
|--|--|--|--|
| | | | |
| | | | |
| | | | |
| | | | |
| | | | |
| | | | |
| | | | |
| | | | |
| | | | |
| | | | |

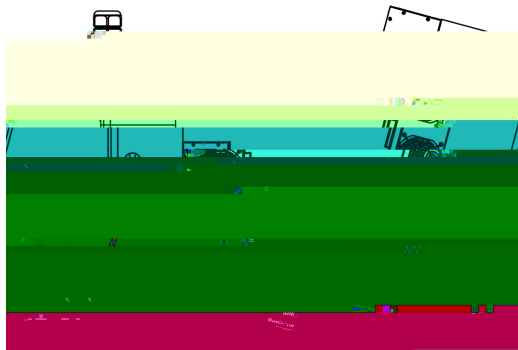
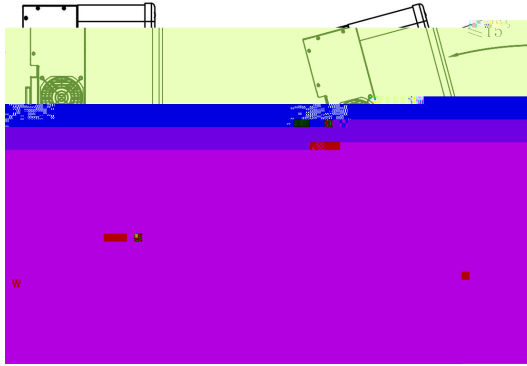

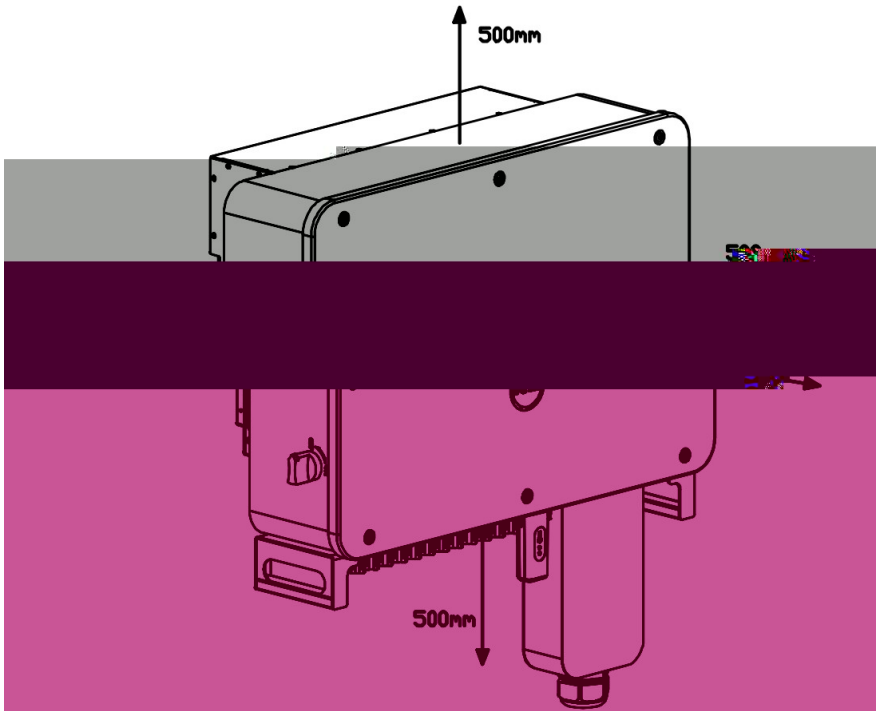

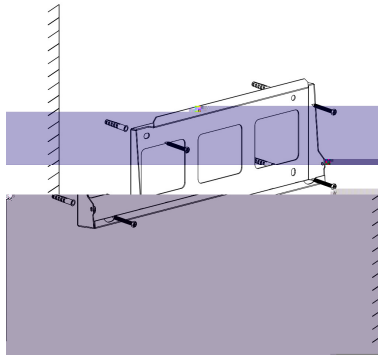
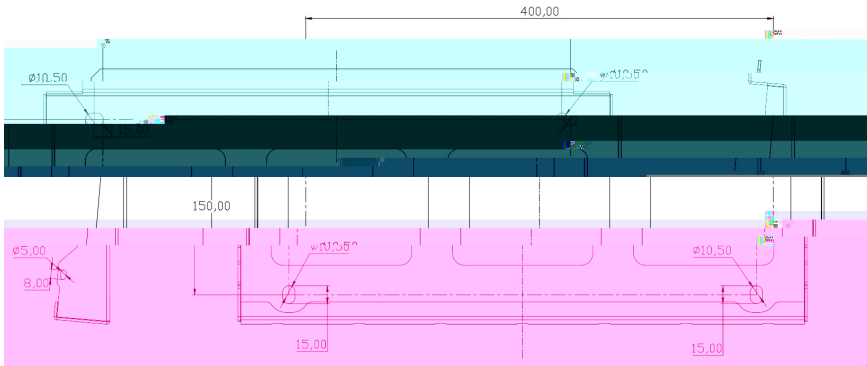

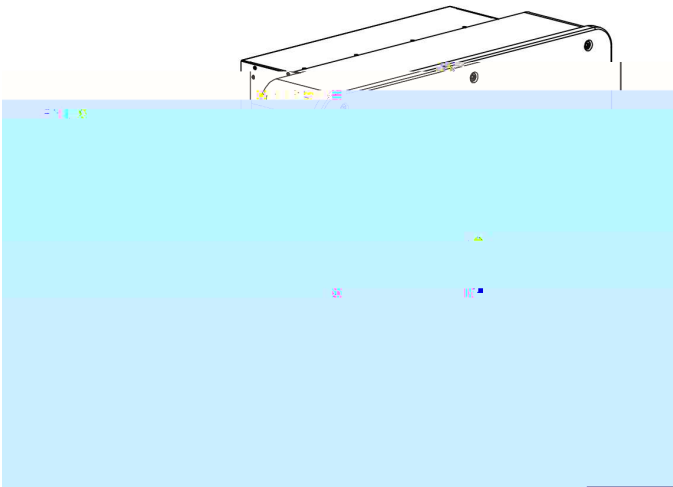

| | |
|--|--|
| | |
| | |
| | |
| | |
| | |
| | |
| | |
| | |



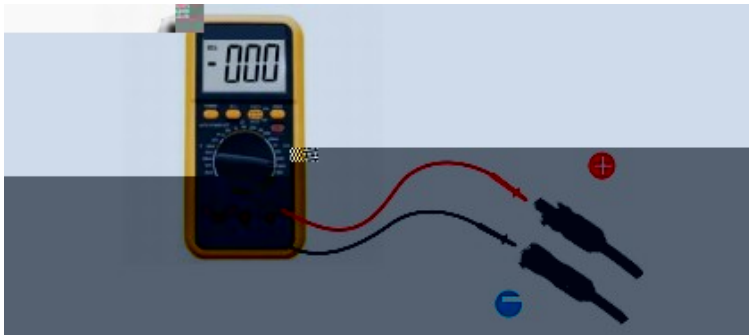
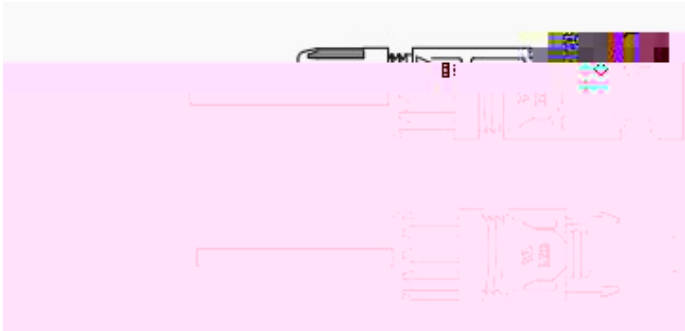
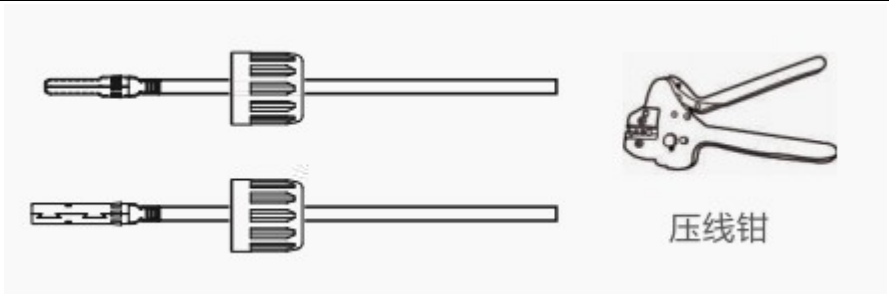

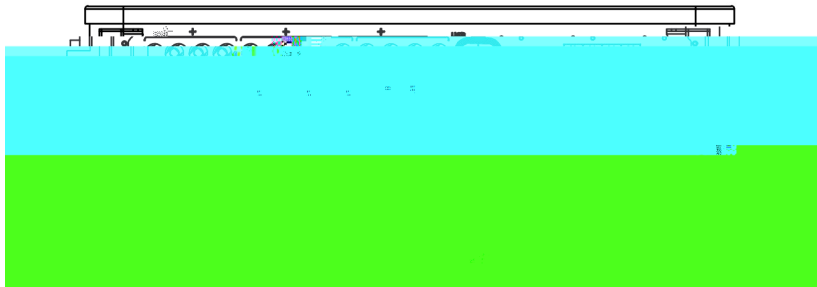



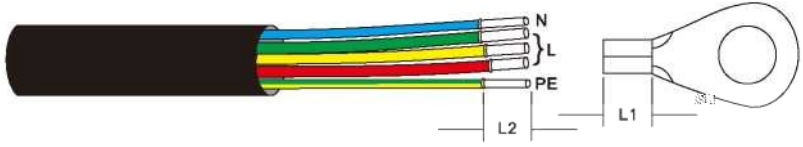

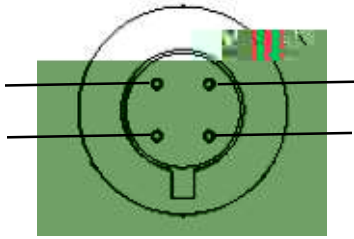
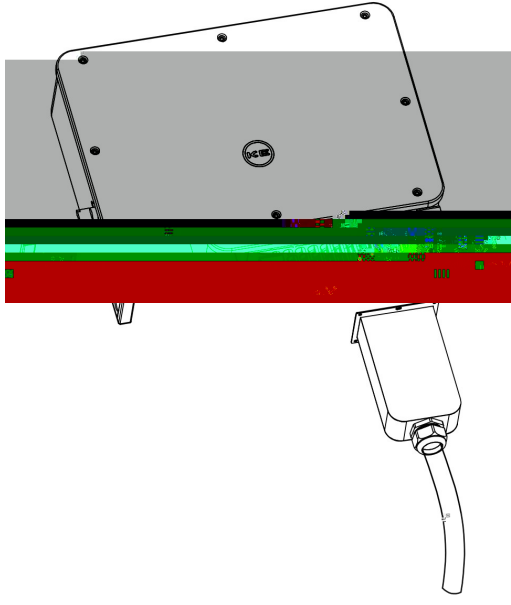



重要:

对于并联的多个逆变器，所有逆变器应连接到同一接地点，以确保接地线等电位连接。

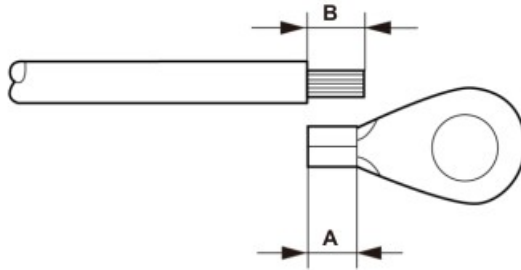

重要:

P (芯线剥皮长度) 比A (OT线缆端子压接区域) 长2mm~3mm。

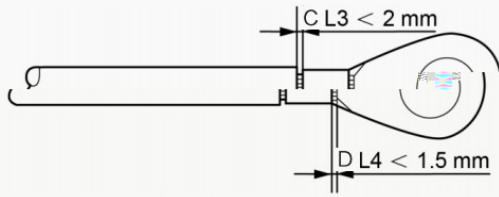

重要:

将端子压接到线缆后，检查连接以确保端子牢固地压接到线缆上。

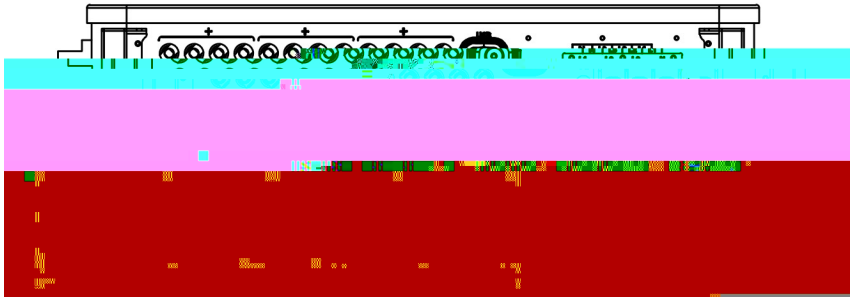

重要:

为提升防腐性能，安装接地线后，建议涂上硅胶或涂料。



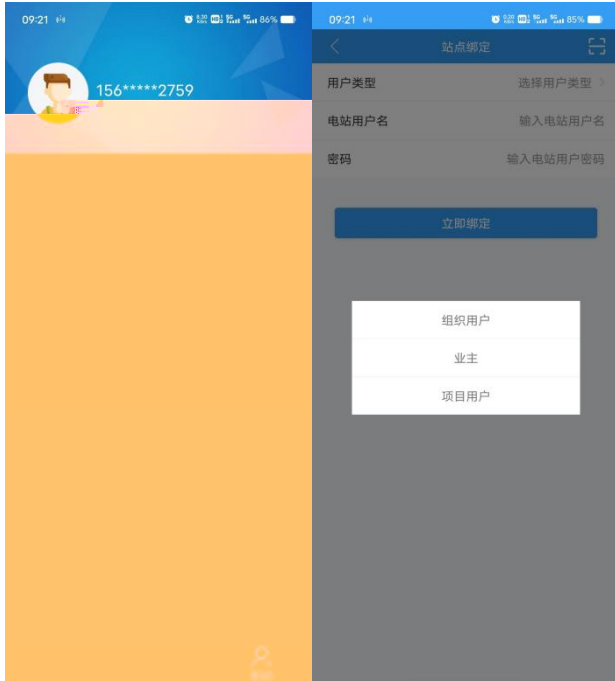

智慧光伏监控运维系统

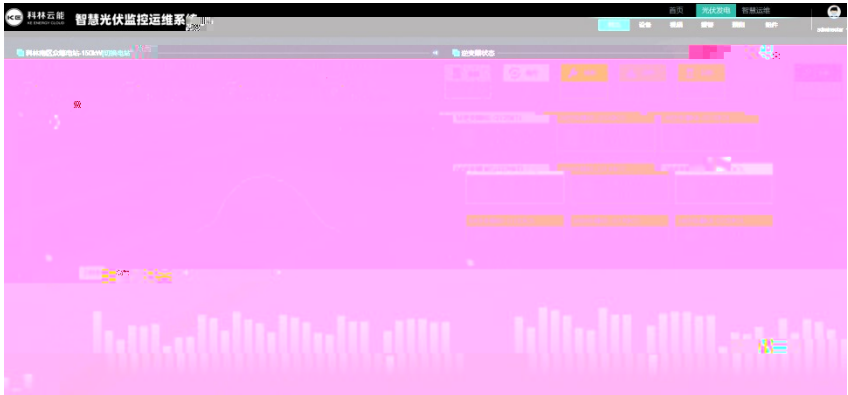
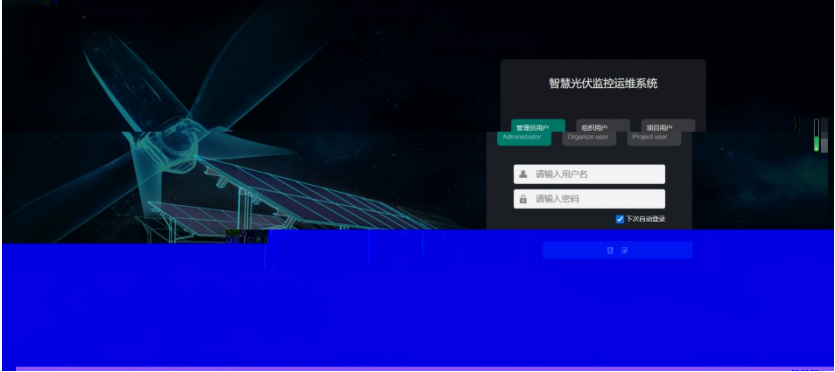

→

→

→

→

→

→

→

→

→

→

→

→

→

→

→

→

→

→

